

## Assembly Instruction

### FLAMRO Variant N II KS

according to ETA-13/0792

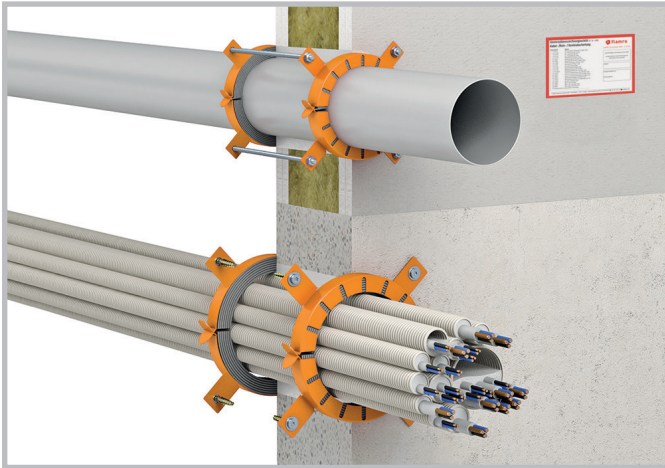

## Content

Target audience, usage of assembly instruction, safety information	2
Components	3
Application field (Component strength, insulation strength and distances)	3
Approved assignments and classifications	4
Approved assignment – wall	8
Approved assignment – floor	9
Applied products	10
Arrangement of the first support (backings)	10
Assembly steps	11
Declaration of performance	13

## Assembly Instruction

### FLAMRO Variant N II KS

according to ETA-13/0792

#### Target audience

This assembly instruction is addressed exclusively to trained experts on fire technology.

#### Usage of assembly instruction

- Please read through the lot of this assembly instruction carefully prior to work start. Regard in particular the following safety information.
- The holder of assessment assumes no liability for damages which are caused by disregard for this assembly instruction.
- Graphic depictions serve as examples only. Assembly results may vary visually.

#### Safety information

For processing of partition components, please regard the safety data sheets.







#### Protection and hygiene measures:

- Observe the usual precautions when handling chemicals. Wash hands before work breaks and immediately after handling the product. Avoid contact with skin, eyes and clothing. Take off stained or soaked clothes immediately.

Eye wash with clean water (EN 15154).

Wear closed work clothing.

	<p>Respiratory protection - Dust mask When exposure limit is exceeded (e.g. possible when turning on), use particle-filtering half mask FFP 1 (white).</p>
	<p>Hand protection - Protective gloves Use waterproof, abrasion- and alkali-resistant nitrile gloves. Different requirements can result depending on application. Therefore observe additional recommendations by the protective gloves' manufacturer.</p>
	<p>Eye protection - Use safety goggles</p>
	<p>Body protection - Use protective work wear</p>

Do not eat, drink or smoke during work. After work is finished, wash all uncovered body parts with water and soap thoroughly.

## Assembly Instruction

### FLAMRO Variant N II KS

according to ETA-13/0792

## Components

### Massive Wände

Depending on the pipe dimensions and desired fire resistance class, the wall must have a minimum thickness of  $\geq 100$  mm or  $\geq 300$  mm and consist of concrete, aerated concrete or masonry with a minimum density of  $600 \text{ kg / m}^3$ . The wall shall be classified in accordance to EN 13501 - 2 for the required fire resistance period.

### Lightweight partition walls:

Lightweight partition walls must have a minimum thickness of  $\geq 94$  mm and consist of steel stands (U and C profiles; 0,5 - 1,5 mm thickness) which are to be coated on both sides with at least two layers of 12,5 mm thick panels of classification A2-s1, d0 or A1 in accordance to EN 13501-1.

Additionally, wood stands can be used instead of steel stands. In this context, it should be noted that there must be a minimum distance of 100 mm between wood stands and partition. The insulation in between those stands must be at least comply with the building material class A1 or A2 (in accordance to EN 13501-1) and have a raw density of  $85 - 115 \text{ kg/m}^3$  (in accordance to EN 1363-1).

The soffit revetment must be built from steel stands with a minimum thickness of 0,6 mm and panels of the same specifications as of the wall.

The supporting structure shall be classified in accordance with EN13501 - 2.

### Rigid floors:

Depending on the pipe dimensions and desired fire resistance class, the floor must have a minimum thickness of  $\geq 150$  mm and consist of concrete, aerated concrete or masonry with a minimum density of  $500 \text{ kg / m}^3$ . The rigid floor shall be classified in accordance with EN 13501 - 2 for the required fire resistance period.

## Application field

Identifier	Wall	Lightweight partition wall	Floor
Thickness of the component	$\geq 100$ mm	$\geq 94$ mm	$\geq 150$ mm
Maximum size of isolated bundles of conduits	$\leq 125$ mm	$\leq 125$ mm	$\leq 125$ mm
Conduits	$\emptyset 16$ to $\emptyset 63$ mm	$\emptyset 16$ to $\emptyset 63$ mm	$\emptyset 16$ to $\emptyset 63$ mm
Maximum outer diameter of applicable collar	$\leq 125$ mm	$\leq 125$ mm	$\leq 125$ mm
Distance to other cable or pipe penetration seals	200 mm	200 mm	200 mm
Distance to other openings or installations	200 mm	200 mm	200 mm

## Assembly Instruction

### FLAMRO Variant N II KS

according to ETA-13/0792

#### Approved assignments and classifications

- > „FLAMRO Variant N II KS“ can be used for electric conduits in wall or floor openings.
- > „FLAMRO Variant N II KS“ must be filled completely with electric conduits.
- > Electric conduits can be unoccupied or completely occupied with cables with a diameter of  $\leq 21$  mm.
- > For bundles of plastic conduits, the outer diameter can be 125 mm.
- > For single penetrations, the conduits' outer diameter can be 63 mm.
- > Conduits which are occupied with cables and unoccupied conduits must not be equipped with a shared pipe collar.
- > Elektroinstallationsrohre müssen rechtwinkelig zur Oberfläche des raumabschließenden Bauteils eingebaut werden.

#### PVC-U PIPES ACCORDING TO EN 1452-1 - WALL

*	Bundle of plastic conduits „FFKuS-EM-F Highspeed“ (also available as „FFKuS-EM-F grau“), manufactured from PVC-U (with / without cable occupation $\emptyset \leq 21$ mm) with a maximum diameter of $\leq 125$ mm: „FFKuS-EM-F Highspeed“ of manufacturer „FRÄNKISCHE ROHRWERKE Gebr. Kirchner & Co. KG“ (Electric installation pipe according to EN 61386-22) with $\emptyset$ 16 mm to 63 mm
**	Bundle of plastic conduits „FFKuS-EM-F-105 Highspeed“ (also available as „FFKuS-EM-F-105“), manufactured from polyolefine (with / without cable occupation $\emptyset \leq 21$ mm) with a maximum diameter of $\leq 125$ mm: „FFKuS-EM-F-105 Highspeed“ of manufacturer „FRÄNKISCHE ROHRWERKE Gebr. Kirchner & Co. KG“ (Electric installation pipe according to EN 61386-22) with $\emptyset$ 16 mm to 63 mm

#### Assignment - cable

*no waveguides*

## Assembly Instruction

### FLAMRO Variant N II KS

according to ETA-13/0792

Flexible walls with a thickness of $\geq 94$ mm and rigid walls with a thickness of $\geq 100$ mm					
Conduits made of PVC-U* with / without cable occupation		Pipe collar „Variant N II KS“ Typ (DN)	E	I	Pipe end configuration
Outer diameter [mm]	wave height [mm]				
16	2.80	63	120	120	C/C
20	3.20				
40	5.00				
50	5.60				
63	7.10				
16	2.80	75	120	120	C/C
20	3.20				
63	7.10				
Rigid walls with a thickness of $\geq 150$ mm					
Conduits made of PVC-U* with / without cable occupation		Pipe collar „Variant N II KS“ Typ (DN)	E	I	Pipe end configuration
Outer diameter [mm]	wave height [mm]				
16	2.80	90	120	120	C/C
20	3.20				
25	3.55				
32	4.30				
40	5.00				
50	5.60				
63	7.10	110	120	120	C/C
16	2.80				
20	3.20				
25	3.55				
32	4.30				
40	5.00				
50	5.60	125	120	120	C/C
63	7.10				
16	2.80				
20	3.20				
25	3.55				
32	4.30				
40	5.00				
50	5.60				
63	7.10				

## Assembly Instruction

### FLAMRO Variant N II KS

according to ETA-13/0792

Rigid floors with a thickness $\geq 150$ mm					
Conduits made of PVC-U* with / without cable occupation					
Outer diameter [mm]	wave height [mm]	Pipe collar „Variant N II KS“ Typ (DN)	E	I	Pipe end configuration
16	2.55	63	120	120	C/C
20	2.90				
40	4.35				
50	5.00				
63	6.25	75			
16	2.55				
20	2.90				
63	6.25	90			
16	2.55				
20	2.90				
25	3.20				
32	3.85				
40	4.35				
50	5.00	110			
63	6.25				
16	2.55				
20	2.90				
25	3.20				
32	3.85				
40	4.35				
50	5.00	125			
63	6.25				
16	2.55				
20	2.90				
25	3.20				
32	3.85				
40	4.35				
50	5.00				
63	6.25				

## Assembly Instruction

### FLAMRO Variant N II KS

according to ETA-13/0792

Rigid floors with a thickness $\geq 150$ mm					
Conduits made of PVC-U* with / without cable occupation		Pipe collar „Variant N II KS“ Typ (DN)	E	I	Pipe end configuration
Outer diameter [mm]	wave height [mm]				
16	2.80	63	120	120	C/C
20	3.20				
40	5.00				
50	5.60				
63	7.10				
16	2.80	75			
20	3.20				
63	7.10				
16	2.80	90			
20	3.20				
25	3.55				
32	4.30				
40	5.00				
50	5.60				
63	7.10	110			
16	2.80				
20	3.20				
25	3.55				
32	4.30				
40	5.00				
50	5.60				
63	7.10	125			
16	2.80				
20	3.20				
25	3.55				
32	4.30				
40	5.00				
50	5.60				
63	7.10				

## Assembly Instruction

### FLAMRO Variant N II KS

according to ETA-13/0792

#### Approved assignment - wall

Bundle of conduits (including single penetrations) in flexible walls with a thickness of  $\geq 94$  mm and rigid walls with a thickness of  $\geq 100$  mm, installed on both sides of the separating building element

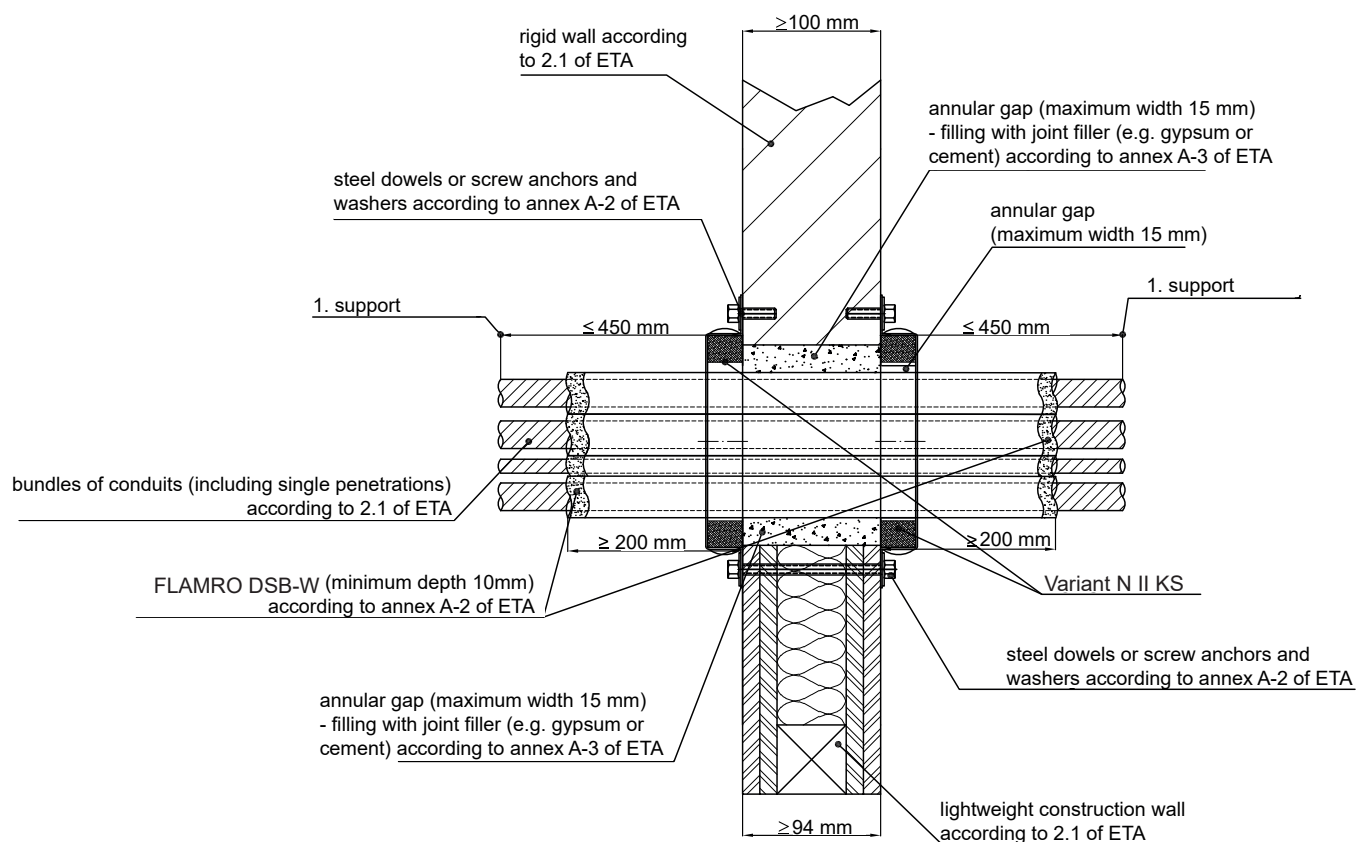

The minimum distance between two pipe collars (linear arrangement, not arranged in groups) in flexible walls and rigid walls is 100 mm (measured from the surface of the pipe collar)



## Assembly Instruction

### FLAMRO Variant N II KS

according to ETA-13/0792

#### Approved assignment - floors

Bundle of conduits (including single penetrations) in rigid floors with a thickness of  $\geq 150$  mm, installed on both sides of the separating building element

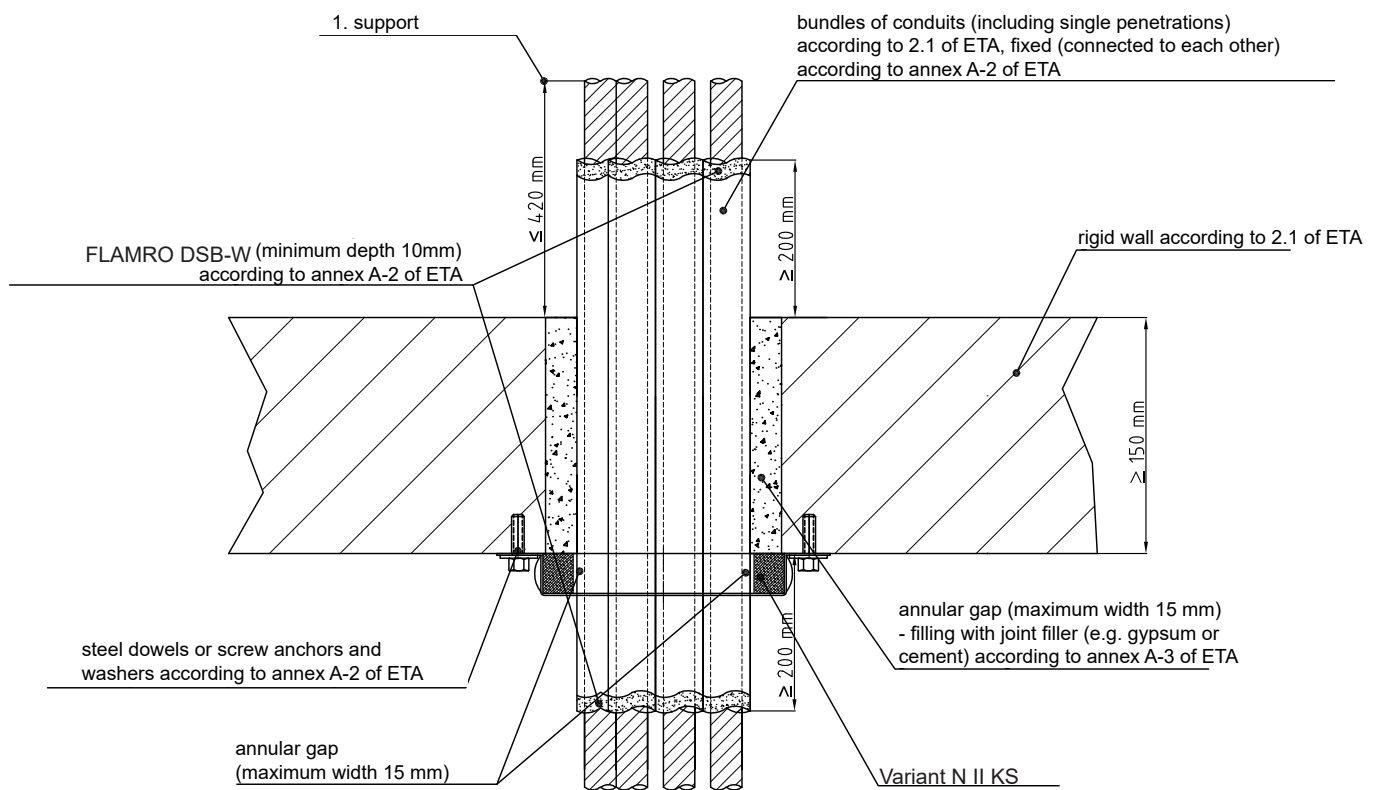





The minimum distance between two pipe collars (linear arrangement, not arranged in groups) in flexible walls and rigid walls is 0 mm (measured from the surface of the pipe collar)

## Assembly Instruction

### FLAMRO Variant N II KS

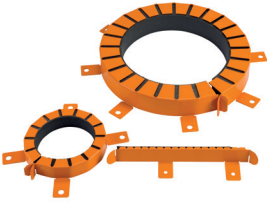
according to ETA-13/0792

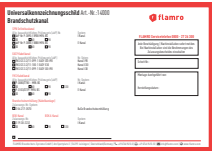
#### Applied products

Bild	Artikelbezeichnung	Art.-Nr.:
	FLAMRO Variant N II A Fire protection collar  Diameter [mm]: 63 75 90 110 125	15063 15075 15090 15110 15125
	Mounting kit Ø 63 – 125 mm	15002
	Identification sign	14000
	FLAMRO DSB-W, 310 ml	31004

#### Arrangement of the first support (backings)

Supports/Backings of the installations in front of the wall insulation must consist of essentially non-combustible components and be arranged with a distance according to the following overview.

For flexible walls and rigid walls, there must be supporting devices (e.g. pipe suspensions) made of metal with a melting or decomposing point of  $\geq 1049$  °C for EI 120 (e.g. stainless steel or galvanized steel) on both sides of the separating element.

Installation	Wall	Floor
Conduits	$\leq 450$ mm on both sides	$\leq 420$ mm above

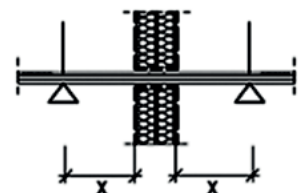

## Assembly Instruction

### FLAMRO Variant N II KS

according to ETA-13/0792

## Assembly

### Guidelines for installation

#### Installation

Conduits and bundles of conduits must be equipped with „ROKU® AWM II“.

It must be used the appropriate, smallest pipe collar fitting to the respective diameter of the insulated conduit or bundle of conduits.

For conduits and bundles of conduits, the annular gap between the conduits or bundle of conduits and the active component (ROKU® Strip) of the pipe collar must be max.15 mm.

The minimum length of conduits or bundle of conduits must be 200 mm on both sides of the separating building element (measured from the surface of the separating building element).

For walls, the pipe collars must be installed on both sides of the separating building component.

For floors, the pipe collars must be installed underneath the separating building component.

The annular gap between the cable(s) and the conduit must be filled with ROKU® AC Brandschutzkitt“ or „Kerafix® Brandschutz-silikon“ up to min. 10 mm on both sides of the separating building element.

Unoccupied conduits must be filled with ROKU® AC Brandschutzkitt“ or „Kerafix® Brandschutz-silikon“ up to min. 10 mm on both sides of the separating building element.

#### Mounting

Bundles of conduits in floor must be mounted (connected to each other) with at least one turn of winding wire (steelwire with a diameter of  $\geq 1,5$  mm) or plastic cable binder after max. 100 mm (measured from the surface of the separating building element) at least underneath the separating building element.

For flexible walls, the pipe collar must be mounted with threaded rods made of steel (size M6 for type DN 63 to DN 75 or size M8 for type DN 90 to DN 125, appropriate for the hole's diameter within fastening clips; length  $\geq$  thickness of the separating building element) and with nut and washer (appropriate for the threaded rods' diameter) on both sides of the separating building element.

For rigid walls and floors, the pipe collar must be mounted with appropriate steel dowers (outer diameter  $\geq 6$  mm) or steel screw anchors (outer diameter  $\geq 7,5$  mm) and washers (appropriate for the steel dowers' or screw anchors' diameter).

#### Annular gap

The annular gap (maximum width<sup>15</sup>) between the insulated conduit or bundle of conduits and the rigid walls or floors must be filled completely with "Joint filler" (non-combustible, dimensionally stable building material with classification A1 oder A2-s1,d0 according to EN 13501-1, like e.g. mortar, cement or gypsum joint filler) on both sides of the separating building component

For bundles of conduits, the space in between the conduits do not need to be filled.

In case of non-insulated flexible walls, it must be ensured that the hollow space of the flexible wall around the annular gap is filled with steelwool of the classification A2-s1,d0 or A1 according to EN 13501-1.

## Assembly Instruction

### FLAMRO Variant N II KS

according to ETA-13/0792

#### Assembly Steps

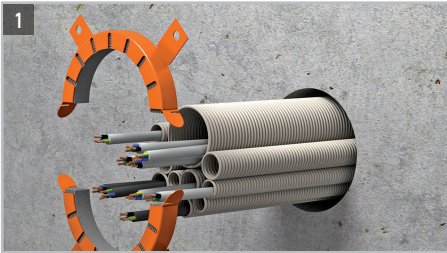

Before the installation of the pipe seal, it is to be checked if all boundary conditions (e.g. type and thickness of wall or floor, type and size of pipes and insulations as well as environmental conditions) comply with the regulations.

For the respective conduit or bundle of conduits, the appropriate pipe collar of type Variant N II A must be picked.

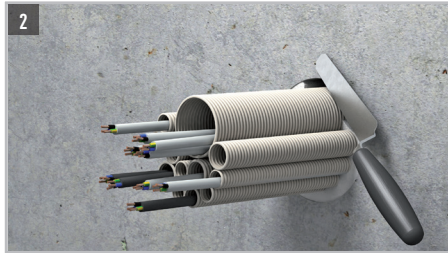

For walls and floors, all remaining joints around the bundle of conduits must be filled with concrete, mortar or gypsum. The gussets between the single conduits do not need to be filled.

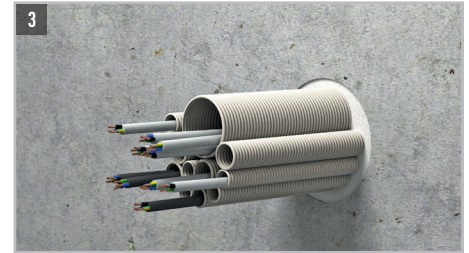

The collar must be mounted with fire protection dowels on both sides of the wall or underneath the floor.



For flexible walls, the fire protection must be mounted with continuous threaded rods M6 or M8.

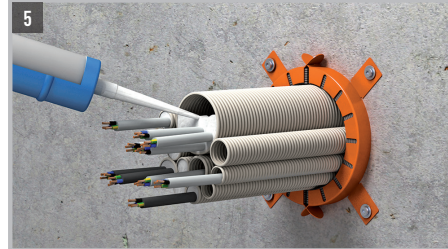

The ends of the conduits must be filled up to 20 mm with FLAMRO DSB-W for smoke protection.

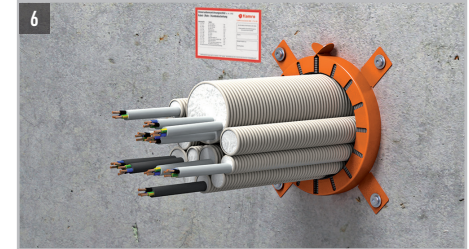

Finally apply the identification sign to the penetration seal. The identification must be placed next to the penetration seal to the building component and is available at FLAMRO Brandschutz-Systeme GmbH.

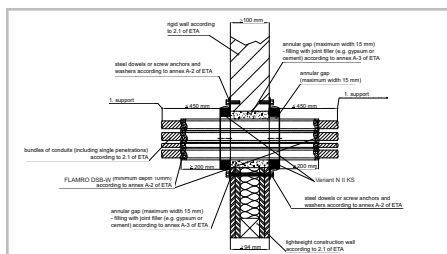

Wall installation

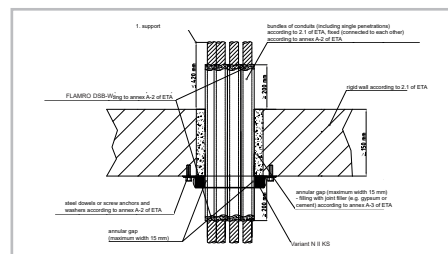

Floor installation



## LEISTUNGSERKLÄRUNG

for the product **FLAMRO Variant N III wrap**

1.	Unique identification code of the product-type:	<b>KA-13-0792</b>
2.	Intended use:	<b>Cable seal</b>
3.	Manufacturer:	<b>FLAMRO Brandschutz-Systeme GmbH Am Sportplatz 56291 Leiningen</b>
4.	Authorised representative:	<b>Not relevant</b>
5.	System(s) of AVCP:	<b>System 1</b>
6.a)	Harmonised standard	<b>Not relevant</b>
6.b)	European Assessment Document:	<b>ETAG-026, Teil 2, August 2011</b>
	European Technical Assessment:	<b>ETA-13/0792</b>
	Technical Assessment Body:	<b>OIB - Österreichisches Institut für Bautechnik, Vienna</b>
	Notified bod/ies:	<b>Materialprüfanstalt für das Bauwesen Braunschweig, NO. 0761</b>

7. Declared performances

Essential characteristics	Performance	Harmonised technical specification
Fire resistance as a cable sealing for flexible PVC or polyolefine conduits in flexible wall -, rigid wall - or rigid floor constructions by means of the fire protection collar type Variant N II A with a maximum dimension of 125 mm.	Max. EI 120	ETA-13/0792
Durability and serviceability	Use category type Y <sub>2</sub>	
Air permeability	NPD	
Water permeability	NPD	
Release of dangerous substances	None	
Mechanical resistance and stability	NPD	
Resistance to impact / movement	NPD	
Adhesion	NPD	
Airborne sound insulation	NPD	
Thermal properties	NPD	
Water vapour permeability	NPD	
Components - reactions to fire	Class acc. to EN 13501-1	
FLAMRO Variant N II A (intumesc. inlay)	E	
FLAMRO Variant N II A (Sheet steel housing)	A1	
*) according to ETA-16/0320		

8. Appropriate Technical Documentation / Specific Technical Documentation:

**Not relevant**

**Website where Declaration of Performance can be viewed:  
www.flamro.com**



The performance of the product identified above is in conformity with the set of declared performance/s. This declaration of performance is issued in accordance with Regulation (EU) No. 305/2011, under the sole responsibility of the manufacturer identified above.

Signed for and on behalf of the manufacturer by:

Dr. Hemp, Head of R&D / Authorised officer, FLAMRO Brandschutz-Systeme  
(Name and position)

Leiningen, 27.10.2017  
(Place and date of issue)

.....  
(signature)